

## Flameless Oxidation

*J. Wüning*

WS Wärmeprozessstechnik, Renningen - Germany

### **Abstract**

Flameless Combustion was first developed to suppress thermal NO<sub>x</sub> formation in burners for heating industrial furnaces using preheated combustion air. While this technique is applied in large numbers now, there are a number of other applications emerging. The presentation will give an introduction into flameless combustion and then show industrial applications and applications which are at a research stage.

- heat treating and heating furnaces in the steel industry
- gas turbines
- bio gas burners
- burners for hydrogen reformers
- burners for CHP units
- and others

## - Introduction

If a combustible mixture of fuel and air is ignited, a flame can develop. In the reaction zone, called flame front, the temperature rises quickly to temperatures close to the adiabatic temperature. The flame can be stabilized within or close to the burner, so that the combustion goes stable and controlled. The different methods for flame stabilization play an important role in the field of burner development. Examples are baffle and swirl stabilization.

For the required flame supervision, optical and electrical effects of flames are used. Modern burner designs use UV or ionisation detectors for automatic flame safety systems. In the absence of a flame signal, the burner is shut off. Therefore it can be said, that flames fulfill two important functions:

- flame stabilisation guarantees a constant and controlled reaction
- and a stable flame provides a steady reliable signal for flame safety systems.

The question is why to give up the proven concept of flames and what are the advantages of flameless oxidation. The main important answer to this question is that flameless oxidation can suppress thermal NO-formation even when highly preheated air is used.

The presentation will provide an overview of the activities around flameless oxidation from the last decade and it will also give an outlook on future potentials.

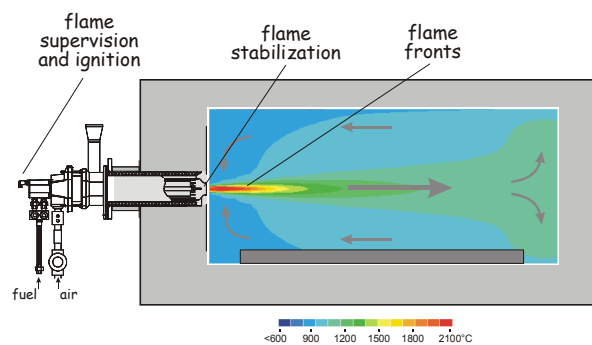


Figure 1: main characteristics of flames

## The Starting Point – The Eighties

Following the first and second energy crisis in the seventies and early eighties, many R&D activities focussed on the improvement of energy efficiency. The most effective method for

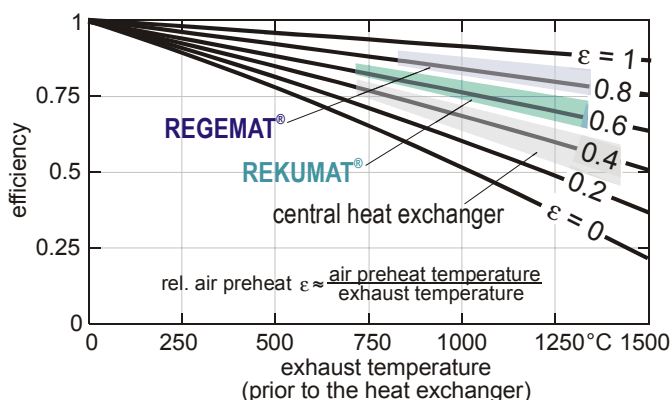
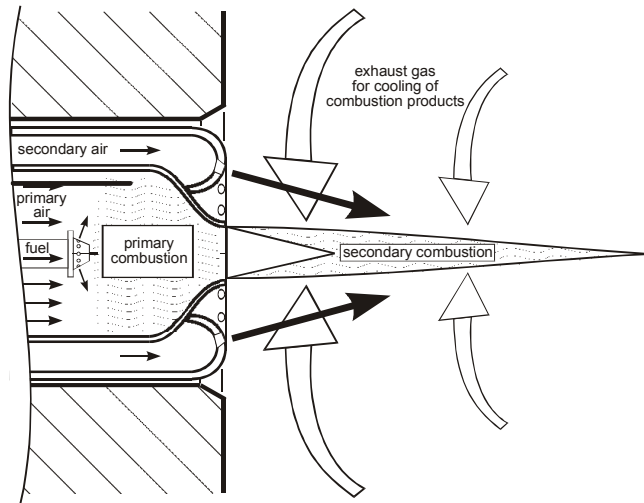


Figure 2: efficiency

improving efficiency of combustion systems, used for high temperature processes, is combustion air preheating. Central recuperators reach air preheat temperatures of up to 600°C. Decentralized air preheat systems allow for much higher figures. Since the air preheat temperature increases approximately linear with the process temperature, the efficiency of combustion systems can be shown in a clearly arranged diagram.

During the same period, the awareness of the negative effects of NO<sub>x</sub>-emissions on human health and the environment put growing pressure on operators and producers of combustion equipment. While NO<sub>x</sub>-emissions were abated with secondary measures in some technical sectors, e.g. catalytic converters in automobiles, the thermal process industry developed and used widely primary measures like staging (see Figure 3). Using these NO<sub>x</sub>-reduction techniques, emission standards like the German TA-Luft could be met for process temperatures up to 1200°C and relative air preheat (~700°C). To meet more rigid existing future limits as well as to apply higher preheat temperatures was not possible.

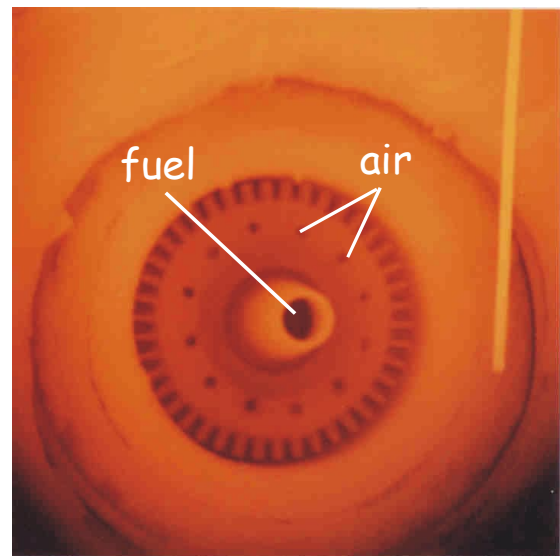
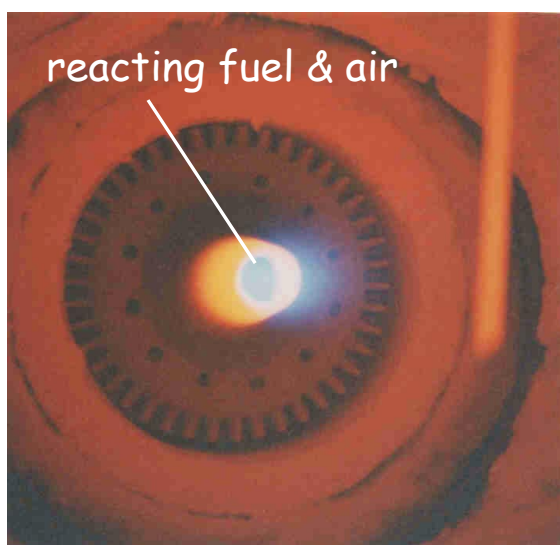


**Figure 3: burner nozzle of an air staged high velocity burner**

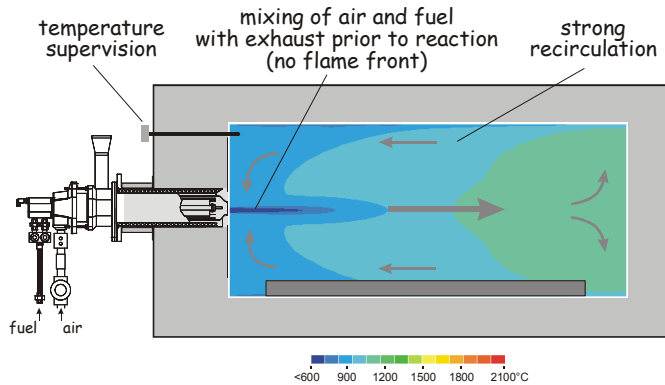
of 0.6  
or  
air

### Combustion without a Flame

In 1989, a surprising phenomenon was observed during experiments with a self recuperative burner. At furnace temperatures of 1000°C and about 650°C air preheat temperature, no flame could be seen and no UV-signal could be detected. Despite that, the fuel was completely burnt. The carbon-monoxide content in the exhaust was below 1ppm. The NO<sub>x</sub> emissions were close to zero, in the single digits, what was first thought to be a malfunction of the NO-analyser. The combustion was stable and smooth, there was no lifted flame. We called that condition flameless oxidation of short FLOX<sup>®1</sup>.



**Figure 4: Flame and FLOX<sup>®</sup>**



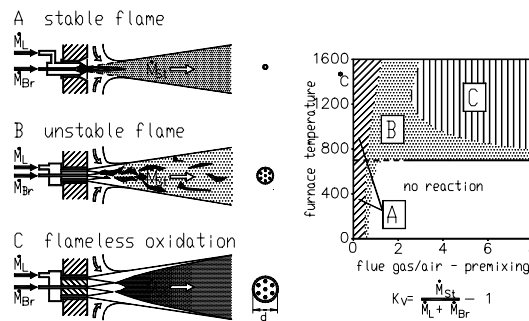
**Figure 5: main characteristics of flameless oxidation**

Further experiments were carried out to determine the essential conditions for FLOX<sup>®</sup>. Fuel and air jets have to be mixed into a strong recirculating flow of exhaust prior to reaction. Then, no flames and therefore no high temperature peaks occur<sup>1</sup>. Air preheat is not a prerequisite for flameless oxidation. The technique of flameless oxidation was patented worldwide<sup>2</sup>.

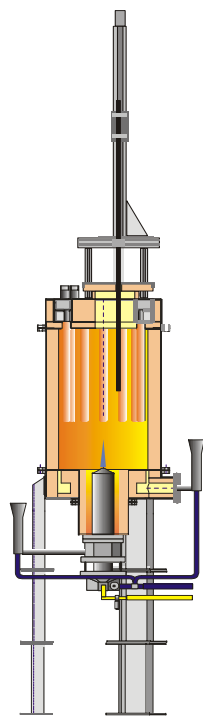
### Investigating the basics – The Early Nineties

While the first FLOX<sup>®</sup> burners were developed and the first commercial burner was sold in 1991, R&D programs were set up to investigate the fundamentals of flameless oxidation<sup>3 4 5</sup>.

Similar to flame combustion, areas of stable combustion for flameless oxidation can be described. In between these areas, unstable and lifted flames occur which are not suitable for technical combustion.



**Figure 6: stability limits**

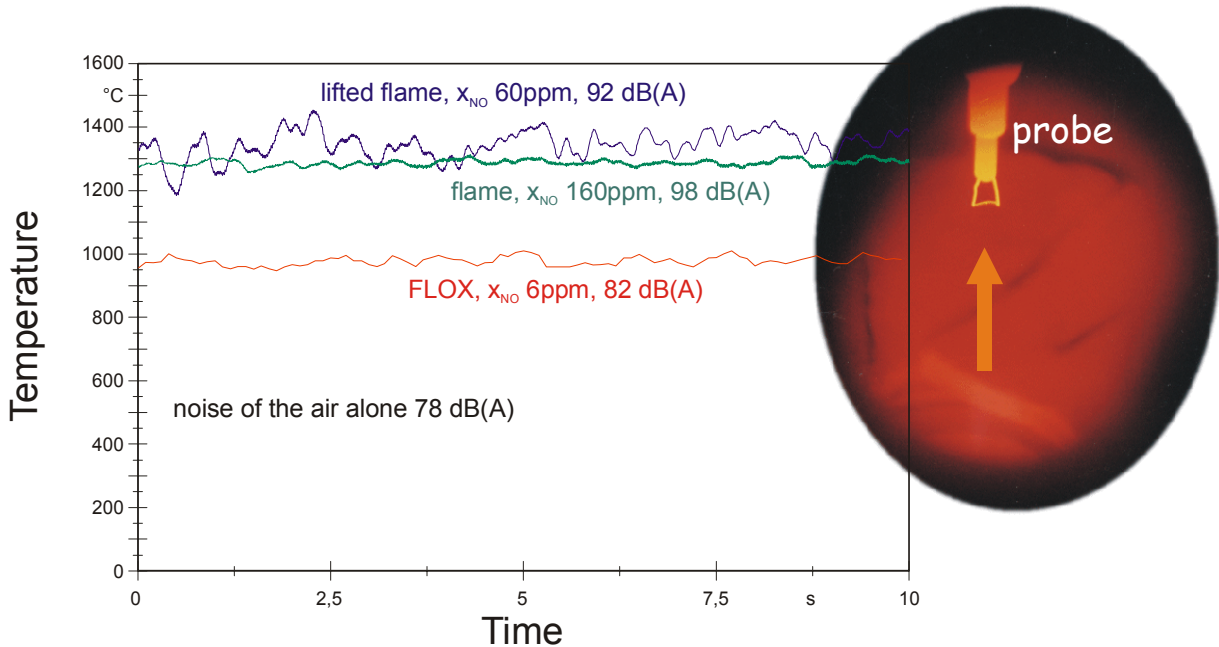


**Figure 7: experimental furnace**

It was found that it is possible to produce highly visible areas with flameless oxidation when conditions allowed fuel to pyrolyse in low oxygen areas to produce shining soot particles.

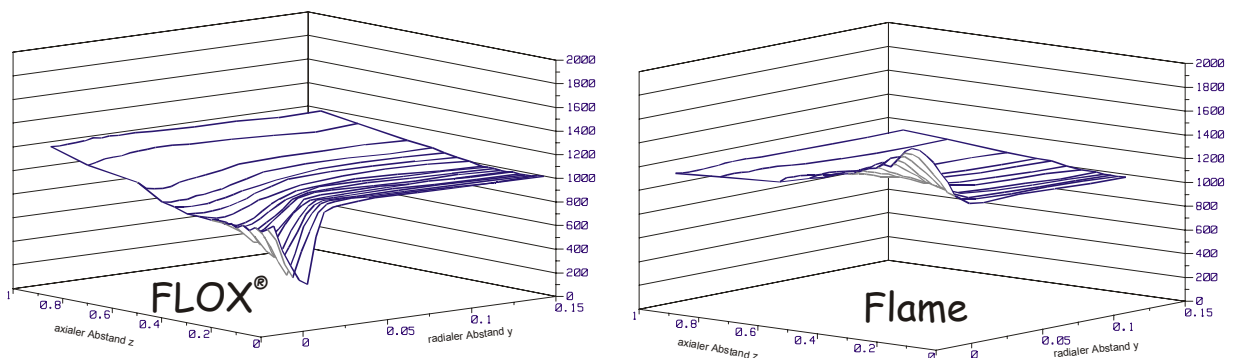
During this period, commercial CFD codes (Computational Fluid Dynamics) became available to run on workstations or PC's. The suitability of CFD codes to simulate flameless oxidation was part of a R&D project, funded by the German Ministry of Education and Research. A test furnace was designed and built to study flameless oxidation and to provide data sets for comparison with result from computer simulations. A recuperative burner was firing bottom-up into a cylindrical furnace, minimizing buoyancy effects. The furnace was equipped with air cooled tubes which were arranged concentric along the furnace wall. Air cooling, in contrast to water cooling, allows for adjustable cooling and make it possible to adjust the furnace temperature widely independent from the burner capacity. The air preheat temperature was adjusted by controlling the amount of exhaust flow, bypassing the recuperator. The non-cooled probe was inserted from the top and could be positioned fully automatic throughout almost the whole furnace. Data collection for several hundred positions in the furnace was possible in about one hour. The probe was equipped to measure temperature, using a 50  $\mu\text{m}$  PtRh Pt thermocouple, pressure and gas samples.

Figure 8 shows temperatures from a fixed position, 250 mm away from the burner.  $\text{NO}_x$  was measured in the exhaust. The burner was operated in flame, lifted flame and FLOX<sup>®</sup> mode. Flame and flameless oxidation mode show steady temperature conditions.  $\text{NO}_x$  and noise are substantially higher in flame mode, compared to FLOX<sup>®</sup> mode.  $\text{NO}_x$  and noise are inbetween for the lifted flame but the temperature signal is highly unstable.

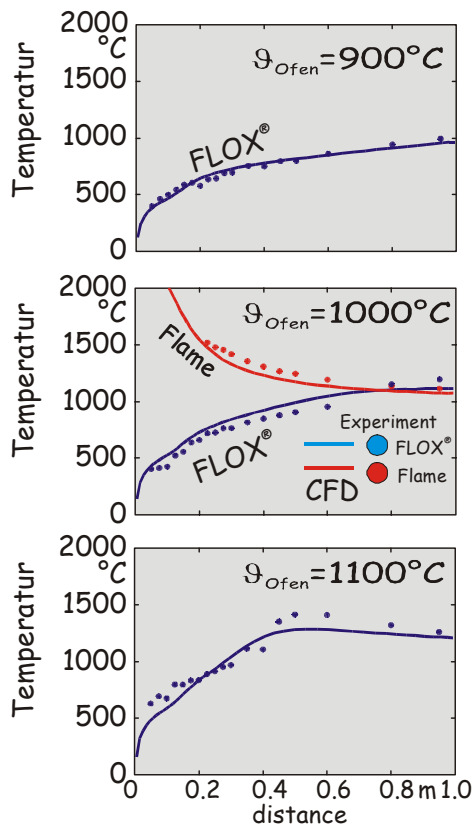


**Figure 8:** time resolved temperature measurement for FLOX<sup>®</sup>, flame and lifted flame

Figure 9 shows temperature fields for FLOX<sup>®</sup> and flame operation. Clearly visible is the different characteristics of the temperature field. High temperature close to the burner nozzle in flame operation (temperature measurements were limited by the thermocouple temperature range), low temperatures in FLOX<sup>®</sup> mode.



**Figure 9:** measured temperature fields of FLOX<sup>®</sup> and flame operation



After determine the suitable sub models and constants for the CFD calculations, the data from the computer simulation and the experiments were compared. The results showed good agreement over wide range of parameter variations except changing the fuel. The predictions of NO<sub>x</sub> predictions were qualitatively and on a technical level satisfying. This allowed for parameter variations (see figure 11) to be calculated in a fraction of time and costs, compared to experiments.

This kind of fundamental investigations were continued by WS GmbH and a number of research groups to the present <sup>6 7 8 9</sup>. One example in figure 12 shows data obtained by laser measurements techniques <sup>10</sup>.

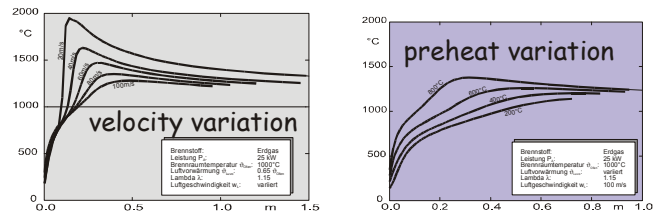


Figure 10: comparison of experimer Figure 11: CFD parameter variations

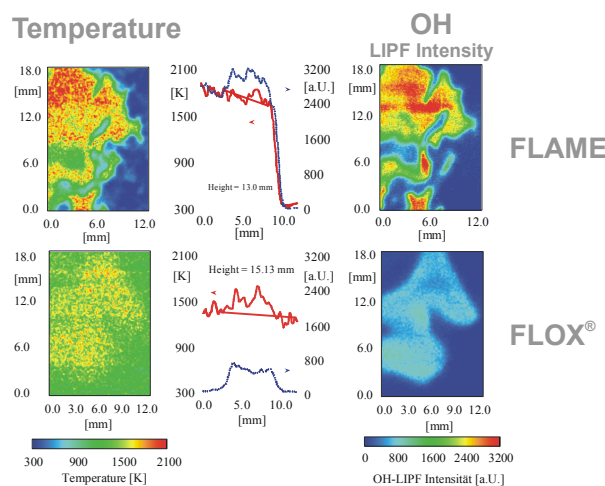


Figure 12: temperature and OH data obtained by laser measurement techniques

Further research will enable predictions of flameless oxidation for a wide range of gaseous, liquid and solid fuels in a wide variety of set-ups as well as improved predictions on emissions.

Among others, one very important result of the investigations was, that it is not necessary to inject fuel and oxidant separately into the furnace. While the "mixed is burnt" approach was used in the beginning, more knowledge about the reaction kinetics allowed for a simultaneous mixture of fuel, air and exhaust, suppressing reaction by slow kinetics. This led to new patented burner designs, called "one-nozzle" FLOX<sup>®</sup> burners<sup>11</sup>.

### **What is flameless oxidation**

There are often discussions going on about combustion can be flameless or not and there is also some confusions about the different definitions for flameless oxidation.

The following definition might give some clarification:

*Flameless oxidation is Stable Combustion without a Flame  
and with Defined Recirculation of Hot Combustion Products*

- for gaseous, liquid and solid fuels
- with and without air preheat
- with and without fuel preheat
- for lean, near stoichiometric and rich combustion (e.g.  $\lambda = 0.3 - 3$ )
- for diffusion, partially premixed and premixed combustion

and:

- it is not necessary to use preheated air
- it is not necessary to operate with low oxygen levels
- no catalysts are required
- there is no need for large combustion chamber volumes
- separate injection of fuel and air not required.

The most definitions for flames refer to visibility, flame fronts, stabilization and equilibrium between flow and flame velocity. All these conditions are not fulfilled in flameless oxidation.

Peters<sup>12</sup> is using another definition relating to the S-shaped curve showing the maximum temperature as a function of the Damköhler number. Heat release combined with temperature sensitive chemistry leads to typical combustion phenomena like ignition and extinction. In case of flameless oxidation, this S-shape curve turns into a monotonous dependence of the temperature on the Damköhler number.

## Exploitation

### Steel Industry

While the first recuperative and regenerative FLOX<sup>®</sup> burners were installed during the early nineties, several FLOX<sup>®</sup> burner designs became a regular serial product for a variety of applications. Most of the burners were installed in heating and heat treating furnaces of the metal and steel industry<sup>13 14 15</sup>. Several projects were carried out which were aiming to develop new burner designs or to investigate the effects of applying flameless oxidation to certain processes.

One of the R&D projects focused on the development of ceramic recuperative burners and radiant tubes<sup>16</sup>. In radiant tubes, and more so in ceramic radiant tubes, efficiency and NO<sub>x</sub> is an important issue since internal temperatures in radiant tubes are substantially higher than the process temperature. A breakthrough was the installation of several hundred ceramic radiant tubes and FLOX<sup>®</sup> burners in a silicon steel strip line in 1994. Up to now, several thousand ceramic burners and radiant tubes are installed<sup>17</sup>. While first designed for high temperature applications to replace electric heating and short living metallic radiant tubes, ceramic radiant tubes were used more and more in lower temperature processes, providing approximately double the heat flux, compared to metallic tubes. Without flameless technology, maintaining acceptable levels of NO<sub>x</sub> would not be possible in many cases.



**Figure 13: silicon steel strip line**

In 1995, a EC funded project started to demonstrate the potentials of a new compact regenerative burner design. The burner uses ceramic honeycomb regenerators which are integrated into the burner.

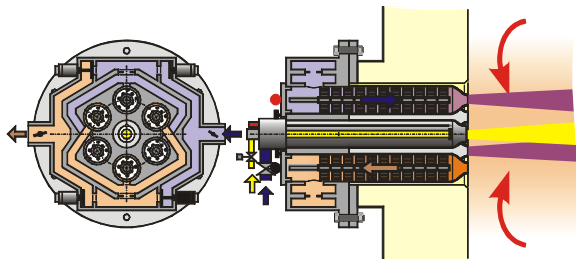


Figure 15: self regenerative burner

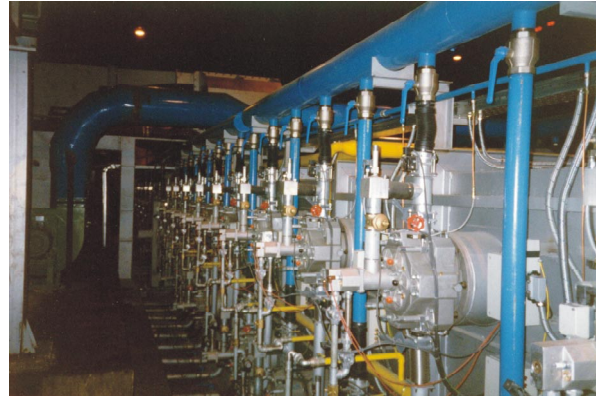


Figure 14: annealing and pickling line in Terni

Figure 16 shows installed regenerative burners in an annealing and pickling line. The specific energy consumption of the furnace was cut in half while the production capacity was increased considerably.  $\text{NO}_x$ -levels are considerably below 100ppm. The furnace is located the steel works of Terni, approximately 100km north of Rome<sup>18</sup>. The recent increases in energy prices have led a growing interest and several new installations.

Another interesting development which is currently launched into the market is the FLOX<sup>®</sup> nozzle field. Preliminary developed for strip preheating, but a number of other applications are promising where high convective and uniform heating is asked for.

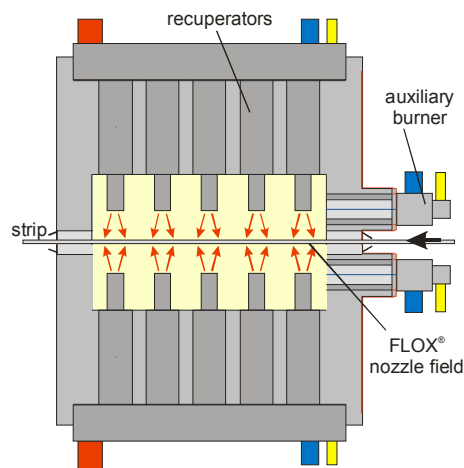


Figure 16: FLOX<sup>®</sup> nozzle field

Flat flame burners are often used when flame impingement is unwanted but the load is placed close to the furnace wall. So far, flat flames were achieved with swirling flames. A swirl free FLOX<sup>®</sup> burner can provide well defined flow conditions, minimum  $\text{NO}_x$  emissions and also allow a self recuperative burner design.



Once the furnace reaches a high enough temperature, the burners are switched into FLOX<sup>®</sup> operation. Then the ceramic combustion chamber are not exposed to high thermal stress any longer.

### **Ceramic Industry**

There is a large potential for new combustion technologies in the ceramic industry. However, often the processes are highly integrated and changes require a lot of research and convincing the customers to leave known paths.

### **Glass Industry**

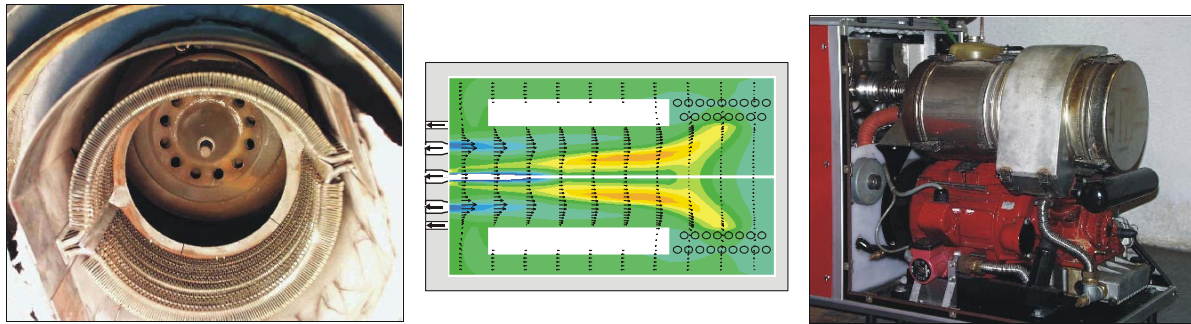
The glass industry is a substantial emitter for NO<sub>x</sub>. Traditionally, the glass industry applied regenerators, providing combustion air preheating and sometimes fuel preheating. Drastic changes to glass melting furnaces are not easy since there is no shut down of these furnaces for modifications. Another factor is that many aspects are based on empiricism rather than well known and understood facts. So its difficult to forecast what would be the effect of changes of the combustion process on the product. But considering the high costs for post exhaust gas treating, every effort should be made to find primary measures for NO<sub>x</sub> reduction.

### **Chemical Industry**

There are highly energy intensive chemical processes. Flameless Oxidation has a large potential, mainly for petrochemical and reformer processes.

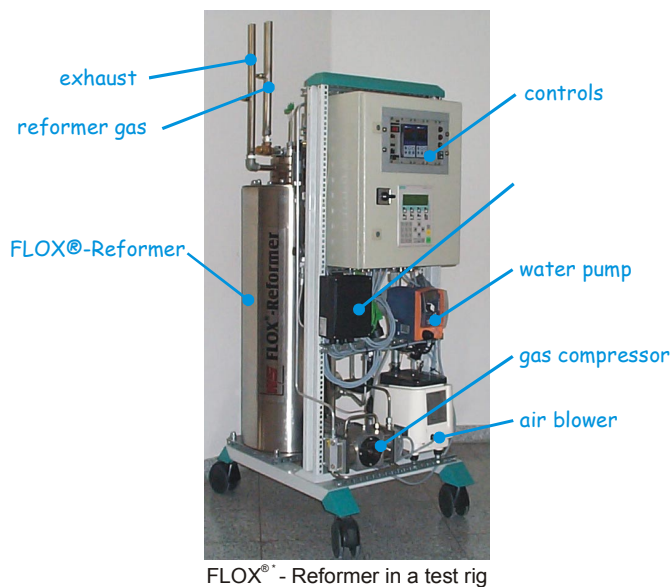
### **Combined Heat and Power**

In another R&D project, a FLOX<sup>®</sup> burner for Stirling engines was developed. Besides low NO<sub>x</sub>-emissions and high efficiency, a compact design and the potential for low production cost, when produced in large series, were important. The Stirling engines are intended to be used as CHP-units (combined heat and power) for decentralized electric power generation.



**Figure 17: burner development for Stirling engines**

In the last years, the efforts to develop fuel cell systems for combined heat and power units, increased substantially. Flameless combustion can play an important role in this field because it seems to be the ideal combustion process for compact reformer units. Reformer units for combined heat and power units are under development. Reformer units for the on-site generation of hydrogen were delivered to two hydrogen fuel stations in Madrid and Munich.



**Figure 18: FLOX® reformer in a test rig**



**Figure 19: FLOX® Reformer at the Munich Airport hydrogen fuel station**

Another promising technology are micro gas turbines which could benefit from flameless combustors.

## Power Generation

Recent projects have shown the potential of flameless combustion in the power generation industry, namely gas turbines<sup>19</sup> ([www.came-gt.com](http://www.came-gt.com)), coal combustion<sup>20</sup> as well as future processes including processes using bio fuels and CO<sub>2</sub> sequestration (see [www.oxy-coal.de](http://www.oxy-coal.de)).

## Bio Fuels

There is a growing interest towards the usage of biofuels for the reasons that they are regrowing and being CO<sub>2</sub> neutral. However, the fuels are often very inhomogenous. Flameless combustion enables low emission and trouble free combustion. The usual problems of flame stability are omitted since there are no flame stability limitations for flameless oxidation. There are a number of research projects, covering these aspects, ongoing right now. (see [www.eu-projects.de](http://www.eu-projects.de) "Bio-Pro" for further information).

## Conclusions

Up to now, more than thousand FLOX<sup>®</sup> burners were installed in many different applications. Often, the reduced NO<sub>x</sub>-emissions were the motivation to apply flameless oxidation, but in many cases:

- more homogenous temperature distribution
- reduced thermal stress for the burner
- reduced noise
- less burner faults
- less restrictions on fuels because no flame stability is required
- 

were also important factors. Development will continue to improve recuperative and regenerative burners. Rising energy costs will favour regenerative concepts due to their higher potential for efficiency.

For some burner designs, licences were granted and further licences will be offered to enable other companies or research groups to use the potential of flameless oxidation on a wide variety of applications.

## Literature

---

<sup>1</sup> Wüning J., Flammenlose Oxidation von Brennstoff mit hochvorgewärmter Luft, Chem.-Ing.-Tech. 63 (1991), Nr. 12, S. 1243-1245

<sup>2</sup> Patent EP 0463218

<sup>3</sup> Woelk G., Wüning J., Controlled Combustion by Flameless Oxidation, Joint Meeting of the British and German Sections of the Combustion Institute, Cambridge, 1993

<sup>4</sup> Wüning J.G., Flammenlose Oxidation von Brennstoff, Thesis, Aachen, 1996

<sup>5</sup> Wüning J.A., Wüning J.G., Flameless Oxidation to Reduce Thermal NO-Formation, Prog. Energy Combust. Sci. Vol. 23, Seite 81-94, 1997

<sup>6</sup> Coelho P.J., Peters N., Numerical Simulation of a Mild Combustion Burner, Combustion and Flame, Volume 124, No. 3, Combustion Institute, February 2001

<sup>7</sup> Tabacco D., Theoretical and Numerical Investigation on Flameless Combustion, Combustion Science Technology, 2001

---

<sup>8</sup> Giammartini S., Girardi G., Cipriani R., Cuoco F., Sica M., Diluted combustion with high air preheatig.: experimental characterisation of laboratory furnaces by means of advanced diagnostics, INFUB 2000, Porto, Portugal

<sup>9</sup> Coelho P.J., Peter N., Numerical Simulation of a Flameless Oxidation Combustor, Combustion and Flame, Vol 124, pp. 503-518

<sup>10</sup> Plessing T., Peters N., Wüning J.G., Laser Optical Investigation of Highly Preheated Combustion With Strong Exhaust Gas Recirculation, Twenty - Seventh Symposium (International) on Combustion / The Combustion Institute, 1998, pp. 3197-3204

<sup>11</sup> Patent EP 0685683

<sup>12</sup> Peters, Turbulent Combustion, Cambridge University Press, 1999

<sup>13</sup> Massingham J, Evaluation of low NOx regenerative burners for steel industry applications, 2<sup>nd</sup> seminar on High Temperature Combustion in Industrial Furnaces, Stockholm, 2000

<sup>14</sup> Wüning J., Regenerative Burner Using Flameless Oxidation, IGRC '95, Cannes, France

<sup>15</sup> Weber R., Verlaan A.L., Orsino S., Lallemand N., On emerging furnace design methodology that provides substantial energy savings and drastic reductions in CO<sub>2</sub>, CO and NO<sub>x</sub> emissions, 2<sup>nd</sup> seminar on High Temperature Combustion in Industrial Furnaces, Stockholm, 2000

<sup>16</sup> Flamme M. Boß M., Brune M. et. al., Improvement of Energy Saving with New Ceramic Self-Recuperative Burners, IGRC, San Diego, 1998

<sup>17</sup> Telger R., Roth W., Betriebserfahrung beim Einsatz von Brennern mit flammloser Oxidation, Gas Wärme International 44 (1995), Heft 7/8, S. 323-337

<sup>18</sup> Milani A., Salomone G.V., Wüning J., Advanced Regenerative Design Cuts Air Pollution, Advanced Steel 1998-99, UK

<sup>19</sup> Flamme M., Al-Halbouni A. Wüning J., Scherer V., Schlieper M., et al., Low Emission Gas Turbine Combustor Based on Flameless Oxidation, 14th IFRF Member Conference, Noordwijkerhout, Netherlands 2004

<sup>20</sup> Fielenbach C., Holfeld T., Petery C. von, Renz U., Wüning J., NO<sub>x</sub>-reduction in a pressurized pulverized coal flame by flue gas recirculation, Pittsburgh Coal Conference, Pittsburgh, USA 2003